

52.572

Viewmate monitor arm - ceiling 572

Use this ceiling mount to attach two flat screen monitors to a ceiling. Used for terminals, information points, point of sale systems etc. One of seven height presets can be set during installation. Afterwards, the height is easily adjusted and fine-tuned using the clamp lever.

- Static height adjustment range of 600 mm (23,6")
- Fixed depth
- Main components made of steel
- VESA MIS-D 75 x 75/100 x 100 mm compatible
- Monitor: tilt +90°/-90°, swivel +90°/-90°, rotate 360°

- Weight capacity max. 15 kg (33 lb) per monitor
- Comes with a ceiling mount
- Monitor size limit: height 1104 mm (43,5")
- Easy to adjust in height using a clamp lever
- Comes with all necessary fasteners

viewmate

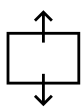
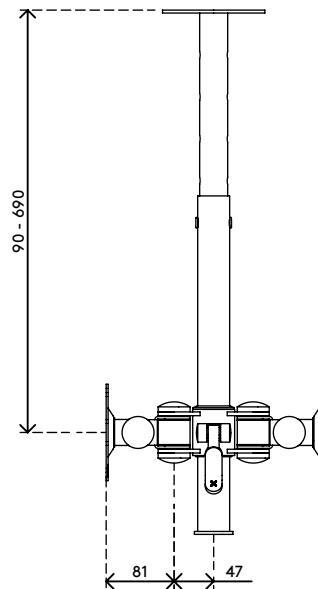
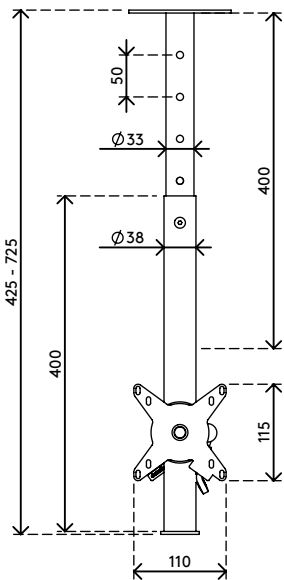
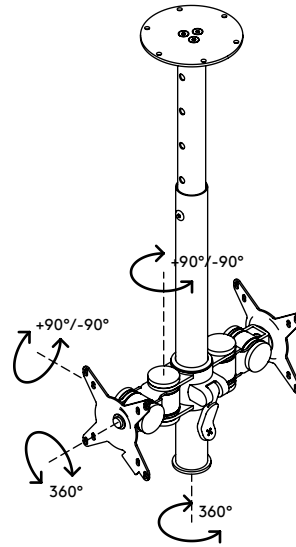
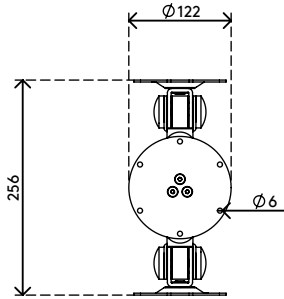

600 mm (23,6")



+90°/-90°

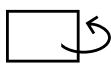

+90°/-90°



360°

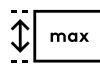

1104 mm (43,5")



75 x 75/100 x 100



(2x) 15 kg (33 lb)

Viewmate monitor arm - ceiling 572

2019/06/20

52.572

 530 x 185 x 135 mm

 1 pcs

 silver

 3,6 kg

 805410525729